



Dragon Fire Series VLQ-2500T (with intercom) 4-channel full function video transmission system



User Manual



Contents

1. About this user manual + Product Overview + Product List -----	01
2. Product Features -----	01
3. Product Specification -----	02
4. Transmitter three side diagram and button definition -----	03
5. Receiver three side diagram and button definition -----	04
6. Intercom system host three side diagram and button definition -----	05
Intercom system host operations -----	05
Intercom system host OLED description -----	06
How to switch the intercom system frequency and Group ID -----	07
Menu setting description -----	07
Intercom system bind operation -----	07
7. Transmitter and receiver initial information description -----	08
Transmitter initial information definition -----	08
Receiver initial information definition -----	08
8. Installation method and instructions for usage -----	09
Transmitter -----	09
Receiver -----	10
Intercom system host -----	11
9. How to bind, how to switch frequency -----	12
How to bind -----	12
How to switch frequency -----	13
10. How to switch video quality -----	14
11. How to switch RTSP, RTSP steaming instructions -----	14
12. About TALLY -----	15
13. RS232/RS422 transparent transmission and PTZ control function -----	16
14. How to switch the 422 serial port baud rate to adapt to different PTZ control commands -----	16
15. Troubleshooting -----	16
16. Attentions -----	17

1. About this user manual + Product Overview + Product List

About this user manual

This user manual introduces VLQ-2500T 4-channel full function wireless video transmission specifications, instructions, attentions and troubleshooting. Before using this product, please carefully read this manual. If you have any doubts or troubles while using this product, please contact us or our dealers.

Product Overview

VLQ-2500T is a innovative full HD wireless video transmission system. It includes four transmitters and one receiver, built in 2.4G intercom system. The four channels video transmission share one RF channel, the best video resolution supports 1080P/60HZ. This product is based on 5G wireless network technology for transmission. It has advanced 4x4 MIMO technology, adopted H.265 encoding and decoding technology for video processing, make the video quality clearer and the latency lower. This product also integrates independent 2.4G intercom system. This system has clear voice, easy to carry. It is a good partner of the team director for live broadcasting.

Product List

• Receiver X1	• Intercom system power adapter X1	• Headset X5	• D-Tap to 2-pin LEMO cable X4
• Transmitter X4		• Network cable X4	• Gooseneck microphone X1
• Intercom system hostX1	• 5.8G antenna X14	• 422 to network cable X4 (optional)	• Double ball head magic arm X4
• Receiver power adapter X1	• 2.4G antenna X6		• SDI cable X8

2. Product Features

■ High quality and low latency

This product supports HD-SDI&3G-SDI input and output, supports HDMI Full HD input and output, the best resolution is 1080P/60HZ. It adopts H.265 encoding and decoding technology with high compression rate and high video quality, the latency as low as 70ms.

■ Optional video quality:

3 different video quality to select, easy to deal with bad wireless environment.

■ Four transmitters and one receiver share one RF channel

This product supports four channels of video signal transmit at the same time, and the best video resolution of each channel can reach 1080P/60HZ. Four channels of video signal share one RF channel, which improves anti-interference ability, saves RF frequency resources, and provides great convenience for users with multiple camera.

■ 4X4 MIMO

Combining 4x4 MIMO technology, this product has advantages over other WIFI products on the market in regards to transmission distance and video bitrate. Beamforming technology makes wireless signal more concentrated and stronger in the direction of transmission to reception, so that the wireless signal can transmit further, more anti-interference, more stable.

■ RS422, RS232 transparent transmission

This product supports RS422, RS232 transparent transmission, which is convenient for the device connected to receiver to transmit control commands to camera, such as the pan-tilt-zoom(PTZ) camera.

■ Support point-to-point and RTSP streaming mode

This product supports both point-to-point and RTSP streaming mode. In point-to-point mode, the product supports four transmit one receive and the video output port is HDMI or SDI. In RTSP streaming mode, the product supports four transmit one receive and four transmit multiple receive, and the video stream port is RJ45 network port. There are more choices for different applications.

■ **Support intercom**

Built-in independent 2.4G intercom module, makes sure the cameramen and director can still get connected by intercom if lost video signal. It is convenient for the whole camera crew during filming.

Each transmitter and intercom system host is equipped with 3.5mm headset jack. The transmitter and intercom system host can work as one-to-one full-duplex intercom or one-to-many broadcasting.

The intercom system has both hands-free and headset dual-function port, and the headset jack supports the popular four-segment 3.5mm mobile phone's earphone in the market.

3. Product Specification

Working Frequency	CH1 5180, CH2 5200, CH3 5220, CH4 5240, CH5 5745, CH6 5765, CH7 5785, CH8 5805, CH9 5825
Antenna Mode	Transmitter 2X2 MIMO external antenna, Receiver 4X4 external antenna
Modulation Mode	OFDM
Transmitting Power	28dbm
EVM	≤-28dB
Receiving Sensitivity	≤-80dBm
Channel Bandwidth	20MHz
Wireless Standard	5.8G 802.11n
Network Encryption	ON
Network Mode	Point-to-Point private protocol, RTSP protocol
Transmission Distance	800m (each channel video bitrate is 8 Mbps)
Transmission Delay	70ms (min)
Bind Function	Support
HDMI Protocol	Support HDMI 1.4
Video Resolution	<p>SDI: SMPTE 296M 720p50,720p59.94,720p60, SMPTE 274M 1080i50,1080i59.94,1080i60,1080p23.98,1080p24, 1080p25,1080p29.97,1080p30 SMPTE424M 1080p50,1080p59.94,1080p60</p> <p>HDMI: 720p50,720p59.94,720p60, 1080i50,1080i59.94,1080i60,1080p23.98,1080p24, 1080p25,1080p29.97,1080p30,1080p50,1080p59.94,1080p60</p>
Audio Format	SDI or HDMI embedded audio Video transmission audio: PCM sampling rate 48KHz 16bits Intercom audio: 3.5mm port analog input and output
Video Compression Format	H.265 encode/decode
Remote Control	RS422default, 232optional

Tally	Support Tally, dual Tally system	
Interface	<p>Transmitter SDI input X1; SDI loop out X1 HDMI input X1; HDMI loop out X1 SMA 5.8G antenna connector X2 SMA 2.4G antenna connector X1 Built-in Tally X1 External 3.5mm Tally input X2 DV port X1 F970 battery slot X1 RS-422 interface X1 LINE IN port X1</p> <p>Intercom module Bind button X1 Intercom module volume plus and minus button X2 Intercom module call button X1 Intercom module headset jack 3.5mm X1 V-mount slot X1</p>	<p>Receiver SDI output X4; HDMI output x4; DB9 (Tally input) X1; Antenna connector X4; XLR input x1; RTSP interface X1; RS-422 interface X4 Power switch X1; OLED screen X1; Button X3; V-mount slot X1</p>
Power Consumption	8W	20W
Operating Power Supply	DC 12V/2A	DC 12V/3A
Temperature Range	-10°C - 50°C (Operating temperature) ; -40°C - 80°C (Storage Temperature)	
Operating Voltage Range	7-17V	

4. Transmitter three side diagram and button definition

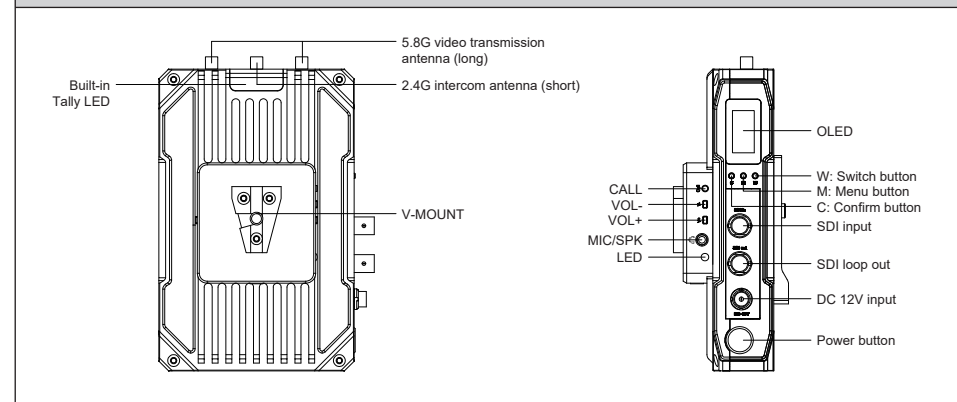

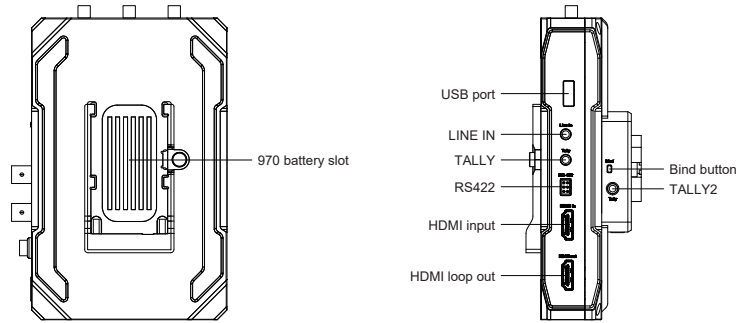

Button	Operation	Description
C	Short press	Confirm button
M	Short press	Menu button: After short press the menu button, enter different menus, total 5 pages, which are: 1. Initial information page 2. RTSP Settings page 3. 422 BaudRate setting page 4. Bind page 5. Video quality selection page
W	Short press	Switch button: Select menu options
VOL+	Short press	Increase the volume of the intercom module
VOL-	Short press	Decrease the volume of the intercom module
Call	Short press	Call intercom system host
Bind	Short press	Bind intercom system host

5. Receiver three side diagram and button definition

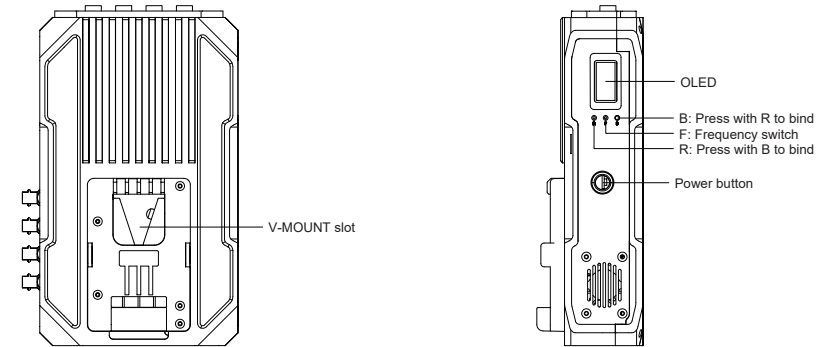
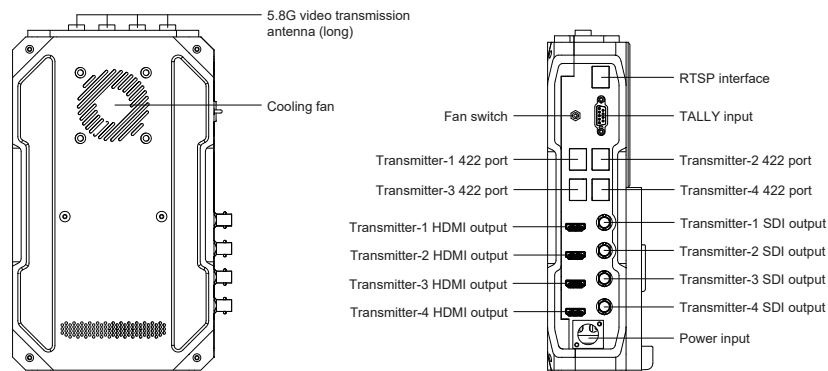

Button	Operation	Description
B	Long press	Press with the R button together, enter bind page. Press the B button can select the options on this page.
F	Short press	Switch frequency
R	Long press	Press with the B button together, enter bind page. Press the R button to confirm.

6. Intercom system host three side diagram and button definition

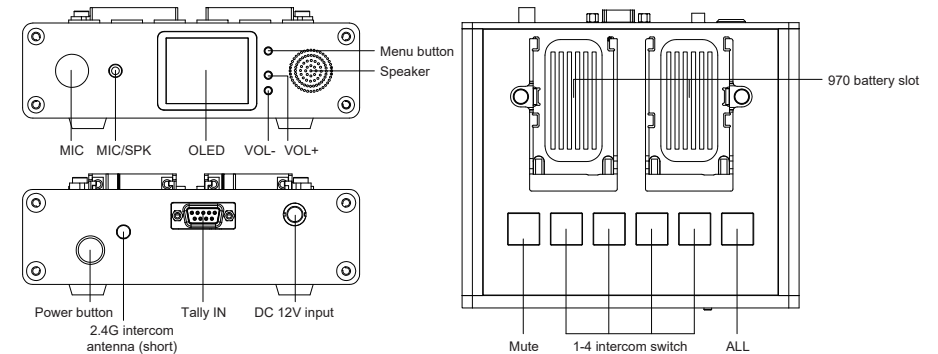

Intercom system host operations

Button	Operation	Description
Menu	Long press/ Short press/ Double click	Short press the menu button to enter the configuration menu. With the VOL+, VOL- button can bind the intercom system host and transmitter's intercom module and switch frequency. In the menu, double click the menu button to select the options. Short press the vol+ and vol- buttons to configure the item. After the configuration is complete, long press the menu button to exit configuration .

ALL	Short press: broadcast	Enter broadcast mode: The intercom system host speak, all the transmitters listen.
1 ~4	Short press one of the buttons: one-to-one full duplex communication	The intercom system host can talk with the corresponding transmitter
MUTE	Short press: Mute	MUTE+ALL press at the same time: the intercom system host mute all the transmitters. Mute+1/2/3/4 button press at the same time: the intercom system host mute the corresponding transmitter.
VOL+	Short press: increase volume	Increase the volume, the system host will remember your current settings and there's no need to reset next time. In the menu setting, it is used to configure the specific item.
VOL-	Short press: decrease volume	Decrease the volume, the system host will remember your current settings and there's no need to reset next time. In the menu setting, it is used to configure the specific item.
Unplug headset	Hands-free mode	The hands-free microphone and speaker turn on.
Plug headset	Headset mode	The hands-free microphone and speaker turn off, and the headset turns on.

Intercom system host OLED description

One-to-one in-call

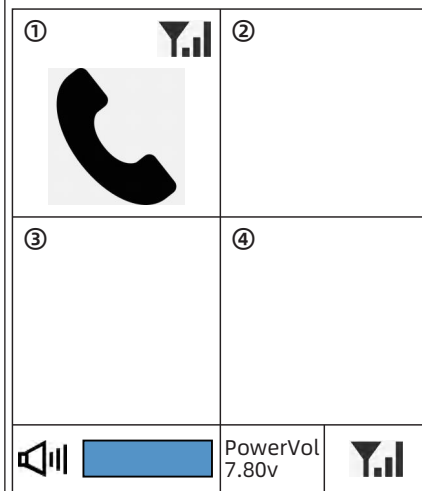

All in-call

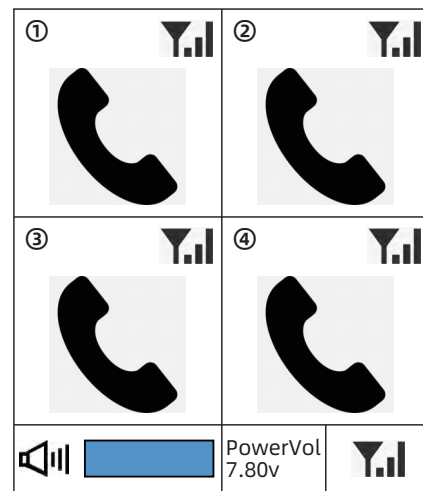

How to switch the intercom system frequency and Group ID

Transmitter

Rotate the hole at the bottom of the transmitter intercom module

Intercom system host

In the default display, short press the menu button to enter the menu setting.
In the menu, double click the menu button can switch Group ID and frequency.

Menu setting description

Master->Group ID:0 <--

This option can configure the Group ID of the intercom system. Different Group ID allows multiple intercom systems to work at the same place same time without interfering with each other. However, if switch the Group ID, the transmitter intercom module must re-bind with the intercom system host. (There are 8 group IDs can be set)

Master->Freq:7

This option can adjust the working frequency of the intercom system. Switch the frequency does not need to re-bind, just makes sure set the transmitter intercom module and the intercom system host at the same frequency. (0-7 channel, total 8 frequency)

Master->Group ID:0 <--
Master->Freq:7

Double press Menu key into setting, Press Vol+ and Vol- for setup.
Long press Menu key to exit setting.

Intercom system bind operation

First, set the transmitter and the intercom system host at the same frequency, and then short press the bind button on the transmitter, the transmitter intercom module LED will flash yellow.

Short press the menu button on the intercom system host to enter the menu setting. If it is already in the menu setting, can directly operate.

Long press any of the "1-4" buttons (if the transmitter is set as intercom 1, long press the button 1, and so on), then transmitter LED will blink green, after that the LED will be yellow. It means the bind process is complete. Long press the menu button on the intercom system host to exit the setting, the two parties can talk normally.

7. Transmitter and receiver initial information description

Transmitter initial information definition



DEV 2
1080P 60
NORMAL
CH6
12.0V

The first line is signal strength status;
"DEV": the number of the transmitter; "2": the transmitter is number 2;
"1080P 60": the current video input resolution is 1080P 60 frames;
"NORMAL": the transmitter is operating in normal mode not RTSP mode. If the transmitter is operating in RTSP mode, the line will show "RTSP";
"CH6": the current working channel is channel 6.
"12.0V": the current input voltage is 12.0V

Receiver initial information definition

11.9V

V1 ON
V2 " " ----
V3 " " ----
V4 " " ----
CH6

"11.9V": the current input voltage;
"V1": the signal source is from transmitter-1;
"ON": the video stream is working normally. If it is not connected, it will show "...";
The bar chart is the signal strength status. If there is no connection, it will show "----". If the current transmitter is operating in RTSP mode, it only shows signal strength, not ON. As this picture, the receiver only connects the transmitter-1, transmitters-2, 3 and 4 does not connected.
"CH6": the current working channel is channel 6.

11.9V

V1 ON
V2 ON ----
V3 ON ----
V4 ON ----
CH6

If the four transmitters are working at the same time, it shows like the above picture.

8. Installation method and instructions for usage

Transmitter

1. Install the two 5.8 G long antennas to the SMA video signal antenna connectors on both sides.
2. Install the 2.4G short antenna to the 2.4G SMA intercom signal antenna connectors in the middle.

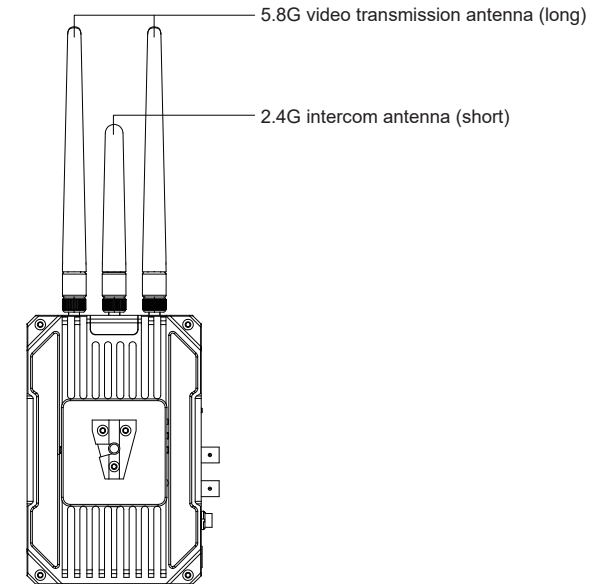

3. Connect the transmitter to the camera via HDMI cable or SDI cable.

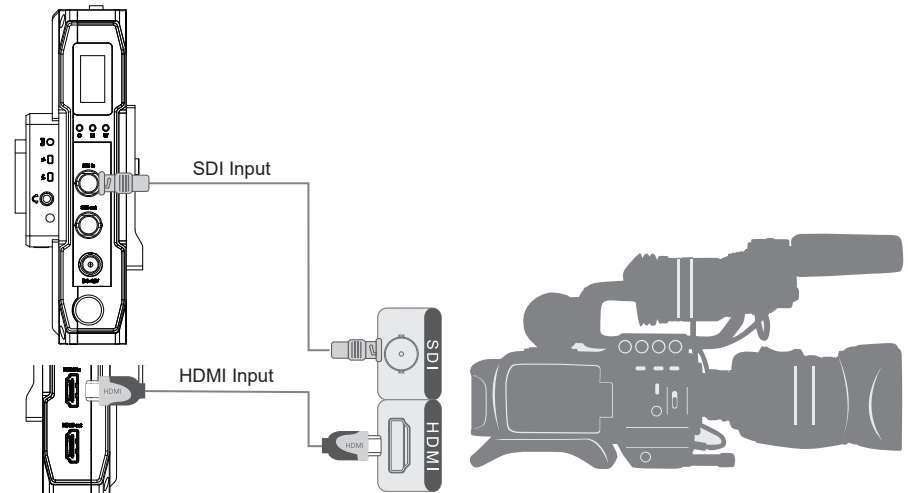

4. Please keep the transmitter over a height of 1.5 meters above the ground to ensure signal quality.
5. To achieve the best signal quality, it suggests to keep at least 1.5-2 meters between multiple transmitters.
6. The transmitter can be powered by an F970 battery or DC 12V power adapter.

Receiver

1. Install four 5.8G antennas to the receiver SMA video signal antenna connectors.
2. Put the receiver at least a height of 1 meter above the ground and fix the base to prevent tipping.
3. Connect the receiver to the switch console or monitor via HDMI or SDI cable.

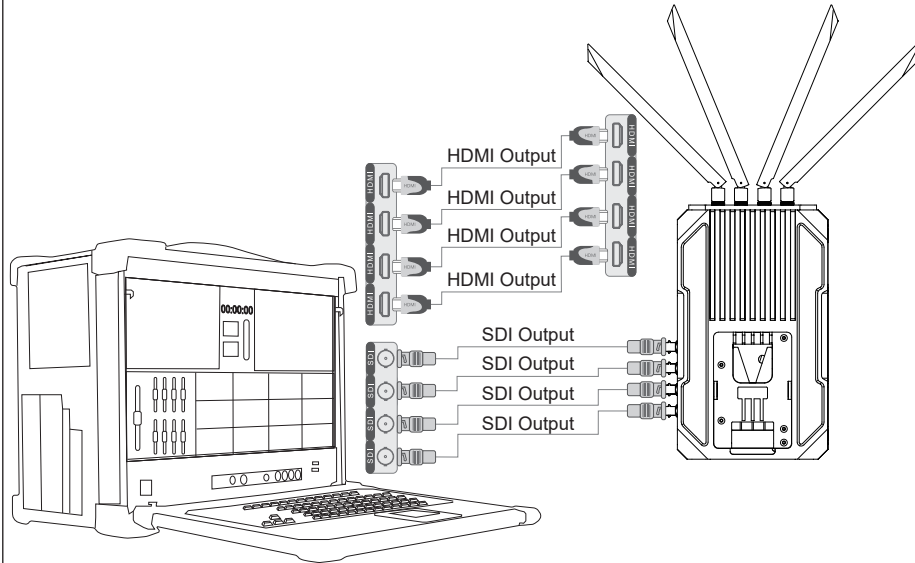

4. The receiver can be powered by the V-mount external lithium battery or connected to the XLR port via a power adapter.

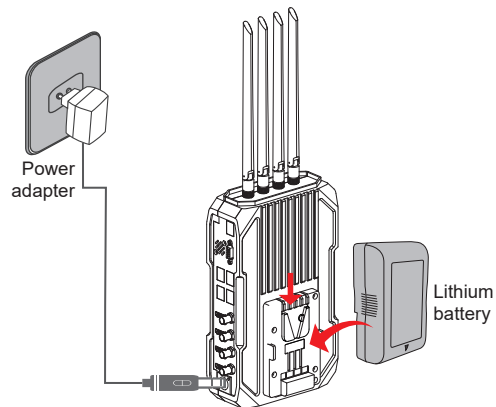

Intercom system host

1. Install the short 2.4G antenna to the intercom system host
2. Power on the intercom system host
3. For the specific operation of the intercom system host, please refer to Part 6 of the manual "Intercom system host three side diagram and button definition"

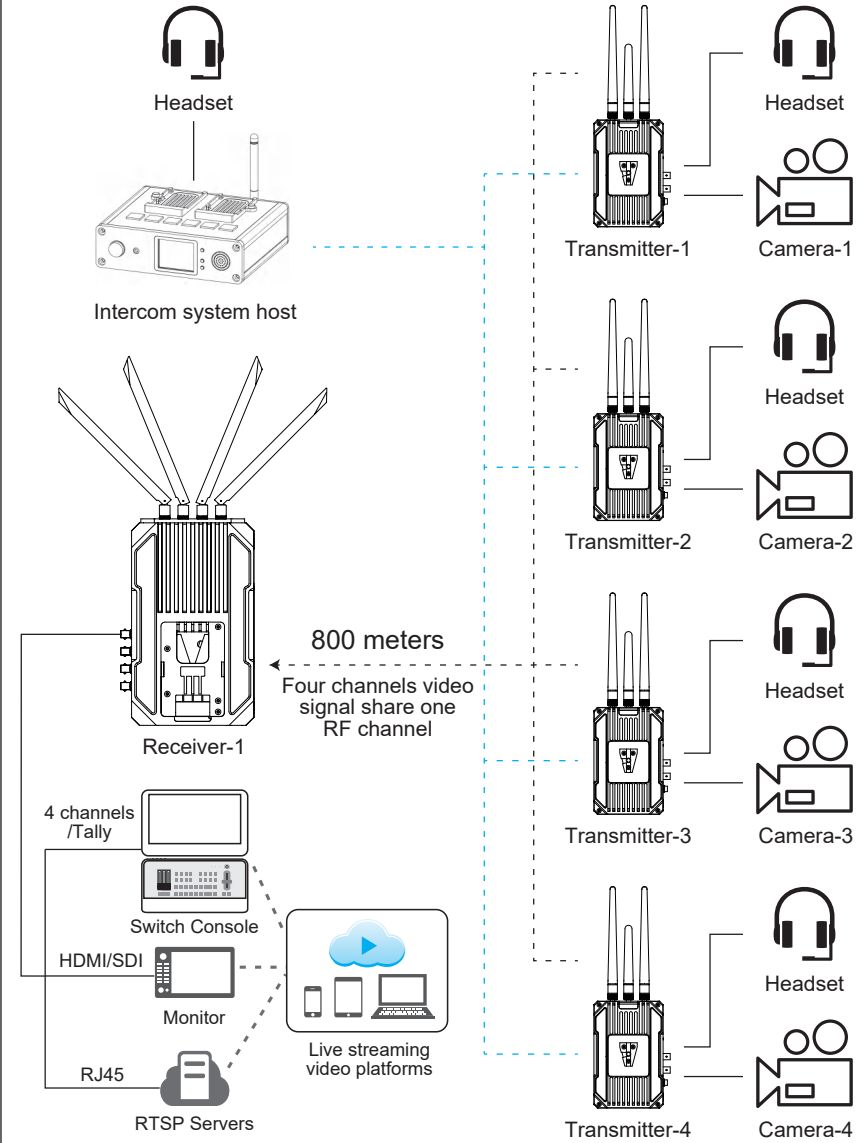

9. How to bind, how to switch frequency

How to bind

The system has finished bind before leaving the factory. If you want to bind the device, first, power on the transmitter and receiver, and wait for about 1 minute. Then do the following operations on the transmitter

(1) Transmitter

Short press the M button, enter wireless page, short press the C button to confirm

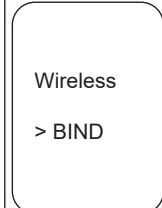

Pop-up dialog box

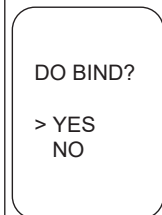

Choose YES, short press the C button to confirm

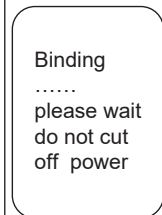

At this time, the receiver can do bind operations

(2) Receiver

Long press the R and B button (the left side button and the right side button) together for 3 seconds, enter bind page.

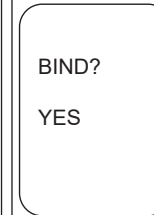

If you do not want to bind, you can press the R button (on the left) to switch, then the page is

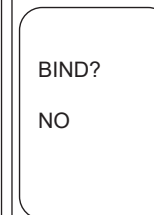

If you want to bind, press the B button to confirm at "YES", and the receiver will also be in bind, and shows the following picture

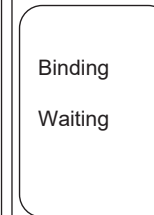

Please wait for the transmitter and receiver to complete binding. Until it shows "Bind Finished" for 3 seconds then return to the default information, it means bind complete.

The receiver can bind with the four transmitters at the same time, and the best way is to quickly set the four transmitters into bind mode and then set the receiver into bind mode. It will improve the bind success rate and save your time.

Attention: The bind process lasts about 3-4 minutes. If the transmitter is connected to the camera at this time, the receiver is connected to the monitor, there may be a brief frame in the bind process. At this time can not disconnect the transmitter and receiver power, please continue to wait until the second time shows a stable and continuous video. That means bind finished. Then you should disconnect the power after bind finished, otherwise will cause bind fails.

How to switch frequency

Long press the F button in the middle of the receiver, the last line of the LCD screen "CH X" will start to blink. "X" is the channel number, it will become the next frequency. It means that the system is switching to the new frequency, wait until "CH" no longer blinking, means that the current frequency point has been successfully switched.

10. How to switch video quality

Short press the M button on the transmitter to switch initial info to video quality

VIDEO Quality

> High
Middle
Low
EXIT

Change to
Middle ?

> YES
NO

Press the W button to select the video quality, and press the C button to confirm. LOW video quality makes sure the system can work steadily in bad wireless environment.

11. How to switch RTSP, RTSP steaming instructions

RTSP streaming mode

In RTSP streaming mode, the four video sources transmit via HDMI or SDI to the four transmitters, and the receiver gets RTSP network signals from the four transmitters, monitors on the switch console via the network port to the router.

When using the RTSP mode, the transmitter needs to switch to RTSP mode.

Short press the M button on the transmitter to enter the RTSP mode, select RTSP, and then short press the C button to confirm.

VIDEO

> NORMAL
RTSP
EXIT

Change to
RTSP ?

> YES
NO

The OLED screen will return back to the initial info and show RTSP, indicating that this transmitter has been in RTSP streaming mode. In this mode, there is no video output from the receiver's SDI or HDMI.

The video signal needs to be transmitted to the streaming software via the LAN port of the receiver for decoding and monitor. Using RTSP streaming mode needs software to decode. There are many streaming software. The following description takes VLC media player for example. Once the transmitter and receiver are connected, the transmitter network indicator light is on, and the receiver network connection shows normally; The transmitter connects the video source via HDMI or SDI, and the receiver connects to RTSP streaming devices through a LAN port.

Take VLC on PC as an example, after opening VLC, select "Media" option, then select "Open Network Stream...". Please enter a the network URL

rtsp://192.168.0.1X:8557/PSIA/Streaming/channels/, "X": the transmitter number. You can check the number on the initial info of the transmitter's OLED screen. If it is number 1, fill in 1. As below:

rtsp://192.168.0.11 :8557/PSIA/Streaming/channels/

If it is number 2, fill in 2. As below:

rtsp://192.168.0.12 :8557/PSIA/Streaming/channels/

4 devices and so on.

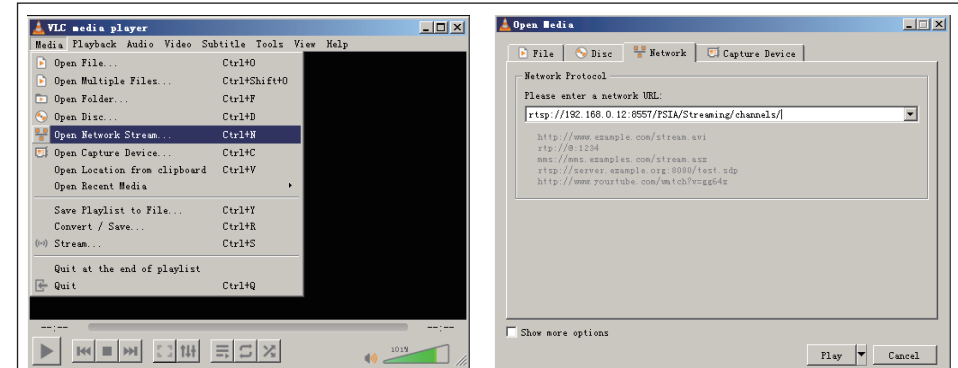

Click "play" to start RTSP streaming.

Attention: the transmitter must be connected to the video source, and the IP Address (e.g. the one used by the PC) of the RTSP streaming device must be on the same network segment as that of the encoding board. Otherwise, the RTSP streaming mode will not work.

12. About TALLY

Tally function instructions

First connect the Tally light to the Tally output port on the transmitter, and then connect the switch console to the Tally input port on the receiver. After all the connection, the switch console can control the Tally light of the four transmitters. When the receiver is triggered at a low level, the transmitter Tally light will be on.

The transmitter tally port and the receiver Tally port is different. The transmitter Tally port is standard Φ 3.5mm headset jack; The receiver Tally port is a DB9 female head interface;

VLQ-2500T system has two channels Tally signals,

One channel is built in the transmitter and receiver, the transmitter built in a Tally light and can also connects an external Tally light.

The other channel is on the intercom system host and the transmitter intercom module (external Tally light is required)

Two channels of Tally signals are independent of each other and do not interfere with each other.

The VLQ-2500T transmitter has an built-in TALLY light, and can also connect to an external Φ 3.5MM TALLY light. The TALLY input port DB9 is defined as follows:

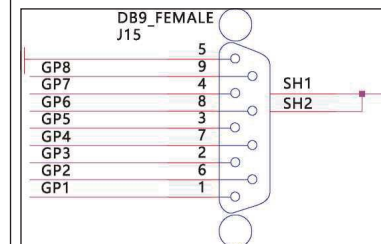

DB9 pin	Tally definition	Description
1	1R	Camera-1 Red
6	1G	Camera-1 Green
2	2R	Camera-2 Red
7	2G	Camera-2 Green
3	3R	Camera-3 Red
8	3G	Camera-3 Green
4	4R	Camera-4 Red
9	4G	Camera-4 Green
5	GND	Ground

13. RS232/RS422 transparent transmission and PTZ control function

Attention: the connector is RS232 by default. If you need RS422, please contact the sales in advance!

The receiver built in four RJ45 network ports arranged in 2X2, the number is 1-4. You can directly connect the switch console 422 network port signal to the receiver 422 network port.

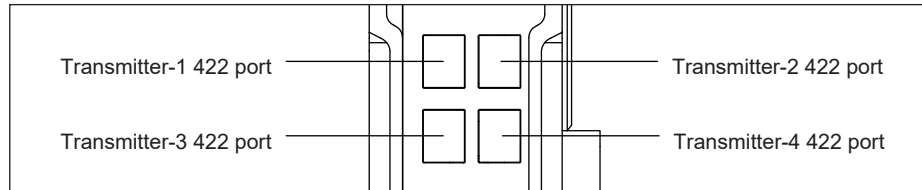

Connect the transmitter 422 port to the network port of the PTZ camera via the 422 to network cable from the accessories, you can realize the 422 transparent transmission.

According to the different PTZ cameras has the different serial port baud rate, you can refer to the next chapter to set the serial baud rate.

14. How to switch the 422 serial port baud rate to adapt to different PTZ control commands

When the transmitter OLED show the initial menu, press the M button to switch to the BaudRate page, press the W button to select the serial port baud rate you need, press the C button to confirm.

BaudRate 2400 9600 19200 > 38400 57600 115200 EXIT	Change to 38400 ? > YES NO
---	---

15. Troubleshooting

Problems	Solutions
If there is mosaic and lag	a) Please place the transmitter and the receiver at a height of 1.5-2 meters above the ground. b) Please arrange the antennas to be fan-shaped, and each has a clear line of sight. c) If the surrounding wireless environment is too complex or you need to the system go through more walls, You can try to set the "Video Quality" to "LOW" to reduce the bitstream and ensure the system works smoothly. When multiple transmitters are working at the same time, please make sure that the distance between each transmitter is at least 2 meters. d) If there is still mosaic or lag, you can try to switch frequency.
If there is frame loss and image tail	Check the software version after changing the latency configuration, and contact technical personnel to confirm. If the software version is too low, you need to upgrade it.

The transmitter and receiver are unable to establish a connection	a) After switching frequency, restart the transmitter and receiver; b) Try to re-bind.
In one-to-one mode, the intercom system host can't hear anything	a) Check if it is in one-to-one mode; b) Re-press the ALL button, then press the number button you want to call; c) Check if the headset plug well; d) Check if the headset is broken, take another headset to plug.

16. Attentions

- First connect the transmitter to the video source with HDMI or SDI cable, then connect the receiver to the monitor, finally turn on the device.
- If the receiver output is black screen after switching the video source resolution, please re-plug the HDMI/SDI cable of the transmitter or receiver. If the system cannot work normally after re-plug the HDMI/SDI cable, please power off and restart the transmitter and receiver.
- When the transmitter and receiver cannot connect for a long time after switching frequency, please power off and restart the transmitter and receiver.
- If bind fails, you can try to rebind. First set the transmitter in bind and then the receiver.
- When the TX and RX connect normally, there is no output on the monitor or only OSD output no normal video output, please re-plug the HDMI/SDI cable connected to the receiver and check if the monitor is standby. When the above operation still cannot output normally, please try to replace the monitor.
- If the video is stuck or mosaic when using the system, it is usually caused by network interference. Please try to switch the system frequency to avoid the interference. For frequency switch operations, refer to chapter 9.
- Please install the antennas before powering on the system. Otherwise, it may cause damage to the system.
- This product's video signal can go through the wall. However, if you need to go through too many and too thick walls, it will affect the use effect. You can consider using LOW video quality options to increase the penetration ability.
- When using the system, the surrounding environment may affect the wireless transmission quality. The poor wireless environment may lead to video and sound distortion, such as video pause, noise and so on. So please pay attention:
 - Walls, large sheets of metal, and various instruments that affect wireless transmission.
 - Try to avoid using this system in these environments.
 - Using this system in crowded areas, please place the transmitter and the receiver at a height of 1.5-2 meters above the ground.
 - If there are 5GHz wireless devices working nearby, these may also cause interference to the system. You can switch to a different frequency manually in this case.
 - Please do not put this system in a metal container, because it will affect wireless transmission. If it is unavoidable, please ensure that each antenna has a clear line of sight.
 - The transmitter and receiver are located at a height of 1.5-2 meters above the ground, please arrange the antennas to be fan-shaped, and ensure each has a clear line of sight.